

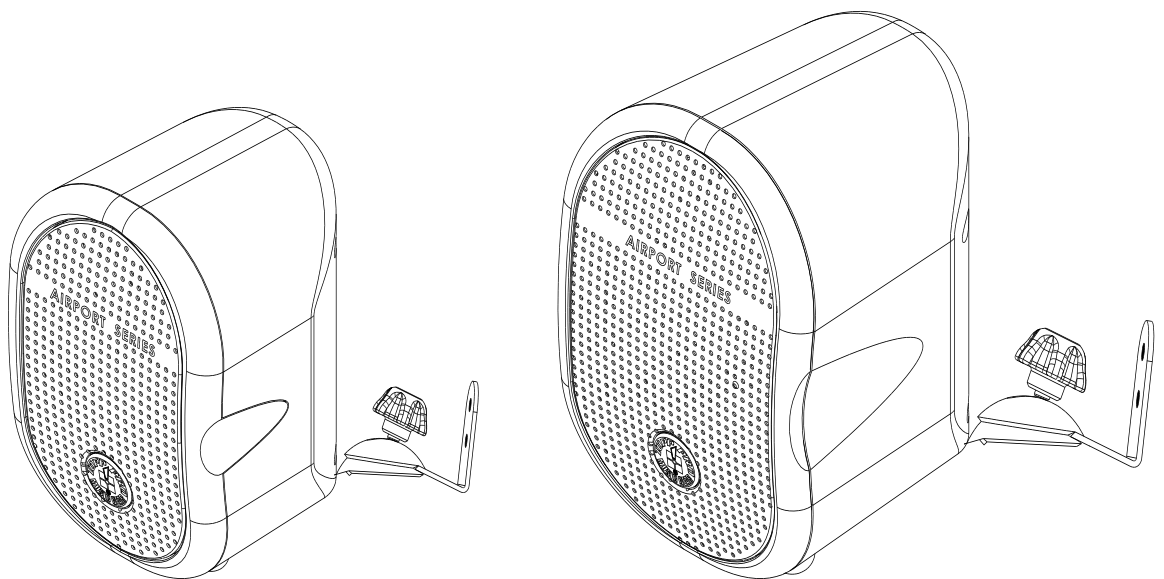

OUTDOORS INDOORS SPEAKER

User's Manual

TAP20A/20T/40A/40T



Safety Related Symbols



This symbol, wherever used, alerts you to the presence of un-insulated and dangerous voltages within the product enclosure. These are voltages that may be sufficient to constitute the risk of electric shock or death.



This symbol, wherever used, alerts you to important operating and maintenance instructions.

Please read.



Protective Ground Terminal



AC mains (Alternating Current)



AC mains (Alternating Current)

ON:

Denotes the product is turned on.

OFF:

Denotes the product is turned off.

WARNING

Describes precautions that should be observed to prevent the possibility of death or injury to the user.



CAUTION

Describes precautions that should be observed to prevent damage to the product.

Disposing of this product should not be placed in municipal waste but rather in a separate collection.

WARNING

Power Supply

Ensure that them a inssource voltage (AC outlet) matches the voltage rating of the product. Failure to do so could result in damage to the product and possibly the user. Unplug the product before electrical storms occur and when unused for long periods of time to reduce the risk of electric shock or fire.

External Connection

Always use proper ready-made insulated mains cabling (power cord). Failure to do so could result in shock/death or fire. If in doubt, seek advice from a registered electrician.

Do Not Remove Any Covers

Within the product are areas where high voltages may present. To reduce the risk of electric shock do not remove any covers unless the AC mains power cord is removed. Covers should be removed by qualified service personnel only.

No user serviceable parts inside.

Fuse

To prevent fire and damage to the product, use only the recommended fuse type as indicated in this manual. Do not short-circuit the fuse holder. Before replacing the fuse, make sure that the product is OFF and disconnected from the AC outlet.

Protective Ground

Before turning the unit ON, make sure that it is connected to Ground. This is to prevent the risk of electric shock.

Never cut internal or external Ground wires. Like wise, never remove Ground wiring from the Protective Ground Terminal.

Operating Conditions

Always install in accordance with the manufacturer's instructions.

To avoid the risk of electric shock and damage, do not subject this product to any liquid/rain or moisture.

Do not use this product when in close proximity to water.

Do not install this product near any direct heat source. Do not block areas of ventilation. Failure to do so could result in fire.

Keep product away from naked flames.

IMPORTANT SAFETY INSTRUCTIONS

Read these instructions

Follow all instructions

Keep these instructions. Do not discard.

Heed all warnings.

Only use attachments / accessories specified by the manufacturer.

Power Cord and Plug

Do not tamper with the power cord or plug. These are designed for your safety.

Do not remove Ground connections!

If the plug does not fit your AC outlet seek advice from a qualified electrician.

Protect the power cord and plug from any physical stress to avoid risk of electric shock.

Do not place heavy objects on the power cord. This could cause electric shock or fire.

Cleaning

When required, either blow off dust from the product or use a dry cloth.

Do not use any solvents such as Benzol or Alcohol.

For safety, keep product clean and free from dust.

Servicing

Refer all servicing to qualified service personnel only.

Do not perform any servicing other than those instructions contained within the User's Manual.

PORTABLE CART WARNING



Carts and stands - The component should be used only with a cart or stand that is recommended by the manufacturer.

A component and cart combination should be moved with care. Quick stops, excessive force, and uneven surfaces may cause the component and cart combination to overturn.

Table of Contents

1. INTRODUCTION4

2. USEFUL TIPS.....4

3. USEFUL DATA4

4. CONTROL ELEMENTS.....5

5. CONNECTION DIAGRAM.....6

6. INSTALLATION DESCRIPTION.....8

7. BLOCK DIAGRAM.....10

8. FREQUENCY RESPONSE DIAGRAM.....11

9. TECHNICAL SPECIFICATION.....12

10. GUARANTEE.....14

Don't forget to visit our website at www.toppopro.com
for more information about this and other Topp Pro products.

1

Introduction

TAP20A/20T/40A/40T are designed for indoor and outdoor installation and public address system. They provide quality performance and alternative two models, including speaker cabinet with transformer and active speaker cabinet. Further more, we offer optional metal rotatable mounting bracket, thus you can install TAP SERIES speakers on wall easily. This new compact speaker series meet every demand for restaurants super market, shopping mall, pubs and so on. For TAP40T, it is equipped with IP44, it can be used in various outdoor applications and situations.

Enjoy your TAP SERIES speaker cabinet and make sure that read this manual carefully before operation.

2

Useful Tips

- Speakers should be placed in a position that allows for unobstructed sound projection. In many instances it is beneficial for speakers to be elevated on tripod stands to achieve maximum dispersion and reach.
- *Use professional advice or service when hanging and installing speakers. Please take precautions to secure them to prevent them from falling and hurting someone. Care should be taken as to not damage the cabinet or its components. Please comply with all pertinent Regulations.
- *Use quality cables. Using quality cables will ensure the best possible sound.
- *For best results match the speakers to a good amplifier that matches the wattage & impedance of your speakers. Proper amplification power results in good quality audio & longer component life. Check out the power requirement for your cabinet.
- *Avoid pointing a microphone directly at an amplified speaker doing so, could cause feedback possibly damaging speaker components and your hearing.

Enjoy the sound!

3

Useful Data

Please write your serial number here for future reference.

Serial Number:

Date of Purchase:

Purchased at:

Control Element

REAR PANEL

1- Input Connection

Use push-button for fixed installation.

The Positive connection is usually marked with (+), or Red push-button. Use it to connect the amplifier output (+).

The Negative connection is usually marked with (-), or Black push-button. Use it to connect the amplifier output (-).

2- Power Selections

With this rotary switch, it is possible to select the power level of TAP20T from 2.5W minimum to 20W maximum, TAP40T from 5W minimum to 40W maximum for two different constant voltages 70V or 100V. In Off position the speaker system is disconnected from the Line. For TAP40T, the bypass is activated in 6 Ohms position.

3- Balanced Input

Use this socket to input signal with a ϕ 6.3 cable.

4- ON/OFF switch

Use this switch to switch on/off power supply.

5- Stereo Input

It is used to input stereo signal.

6- LINK

It is used for outer signal output and be connected with other active speaker cabinets.

7- Volume Control

It is used to adjust the main volume.

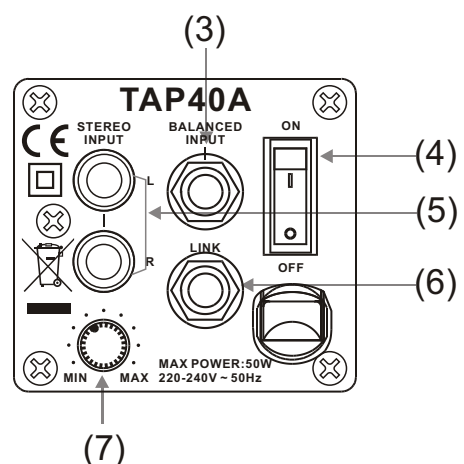
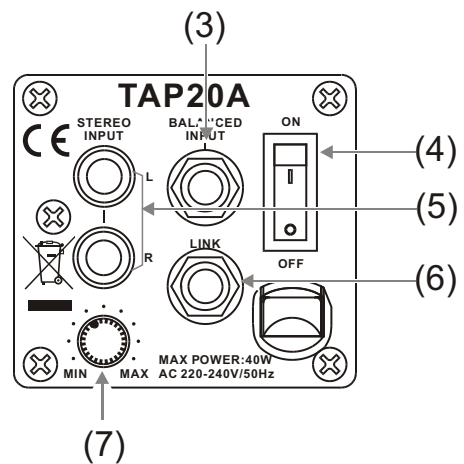
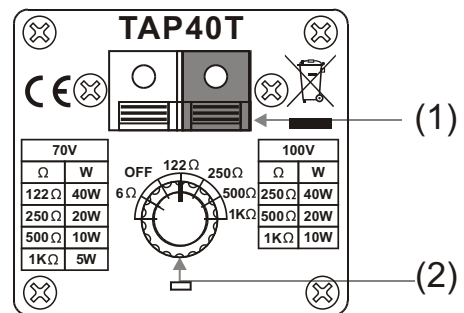
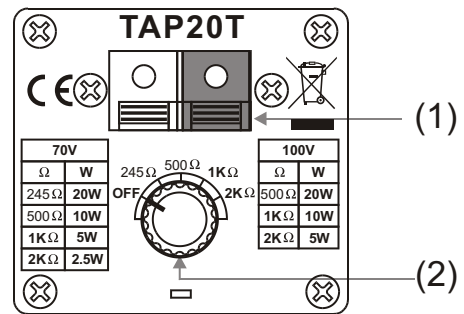

5 Connection Diagram

LEVEL DISTRIBUTION SYSTEM FOR TAP20T

Level distribution system only controls "T" model. TAP20T have built-in transformer of 70V/100V, can connect many speakers to one channel, and only need one amplifier. The amplifier output terminal "com/-" stands for negative polar, terminal "70V/100V/+" stands for positive. The red speaker terminal stands for positive, black stands for negative. Please connect amplifier to speaker right, incorrect connection may cause damage to amplifier and speaker. Finally set your desired output power, see picture A to adjust band switch to meet your need, in this case, the total power of all the speakers can't exceed the nominal power of amplifier. One 80W amplifier channel can drive 8 speakers of 10W, i.e. $10 \times 8 = 80 \leq 80W$). For safety, the total power of all the speakers should be less than 3/4 nominal power of amplifier. (One 80W amplifier channel can drive 6 speakers of 10W, i.e. $10 \times 6 = 60W \leq 80W$).

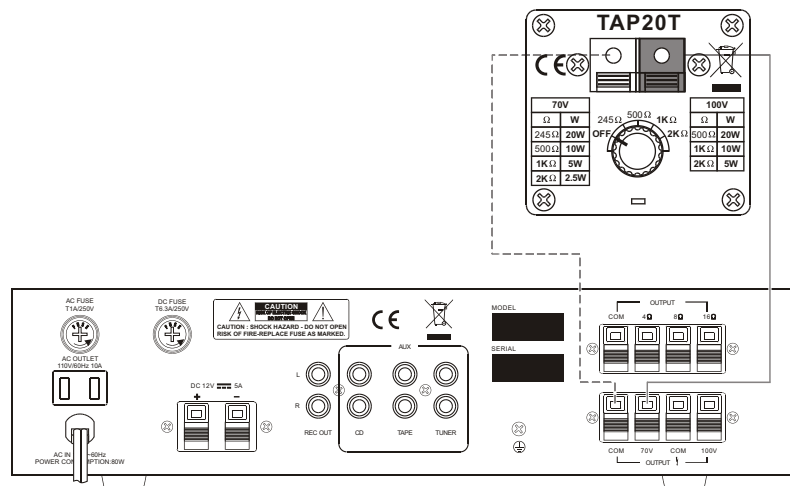

(Figure A)

6x10 WATT=60 WATT TOTAL LOAD ON AMPLIFIER

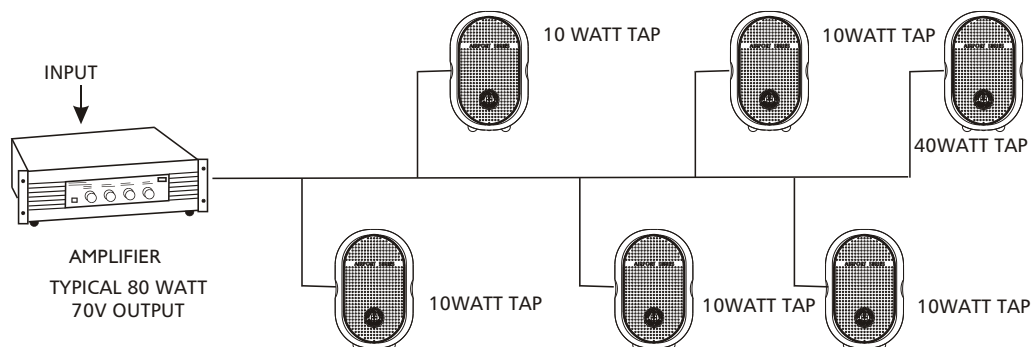

(Figure B)

Connection Diagram

LEVEL DISTRIBUTION SYSTEM FOR TAP40T

Level distribution system only controls "T" model. TAP40T have built in transformer of 70V/100V, can connect many speakers to one channel, and only need one amplifier. The amplifier output terminal "com/-" stands for negative polar, terminal "70V/100V/+" stands for positive. The red speaker terminal stands for positive, black stands for negative. Please connect amplifier to speaker right, incorrect connection may cause damage to amplifier and speaker. Finally set your desired output power, see picture C to adjust band switch to meet your need, in this case, the total power of all the speakers can't exceed the nominal power of amplifier.

One 320W amplifier channel can drive 8 speakers of 40W, i.e. $40 \times 8 = 320 \leq 320W$). For safety, the total power of all the speakers should be less than 3/4 nominal power of amplifier. (One 320W amplifier channel can drive 6 speakers of 40W, i.e. $40 \times 6 = 240W \leq 320W$).

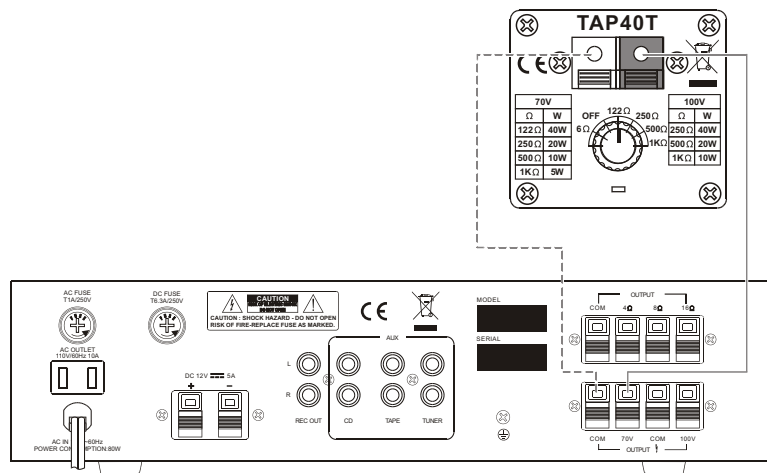

(Figure C)

6x40 WATT = 240 WATT TOTAL LOAD ON AMPLIFIER

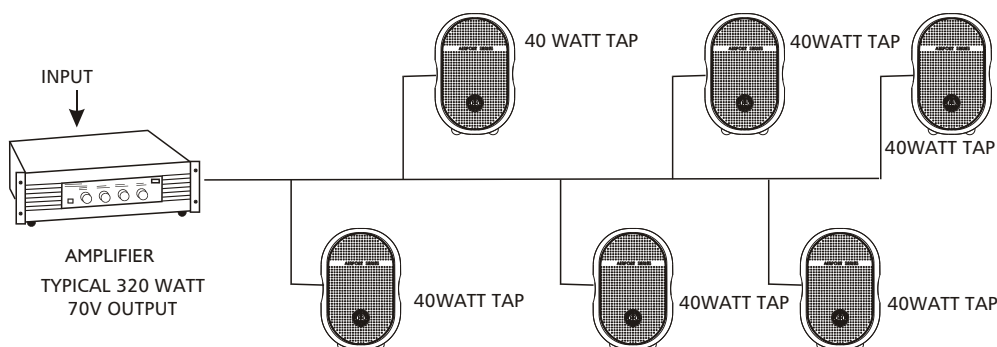

(Figure D)

6

Installation Description

Note: Commercial audio installation system must conform to local building laws. When install speaker on wall or ceiling, please consult a building designer with a license or a professional engineer. The corporation won't be responsible for the improper installation or damage because of not conforming to installation description.

Installation procedure of the bracket (bracket CS-2 is for TAP20A/20T, CS-3 for TAP40A/40T) is very simple & convenient, the appearance is pleasing to the eye.

Step 1: Fasten the bracket(1) on the wall with screws. The wall material must support the weight of the cabinet.

Step 2: Place the body of cabinet in bracket(2) and lock the screws tightly.

Step 3: Use screw (3) lock bracket(1) and bracket(2), and use steel rope (4) to connect two brackets.

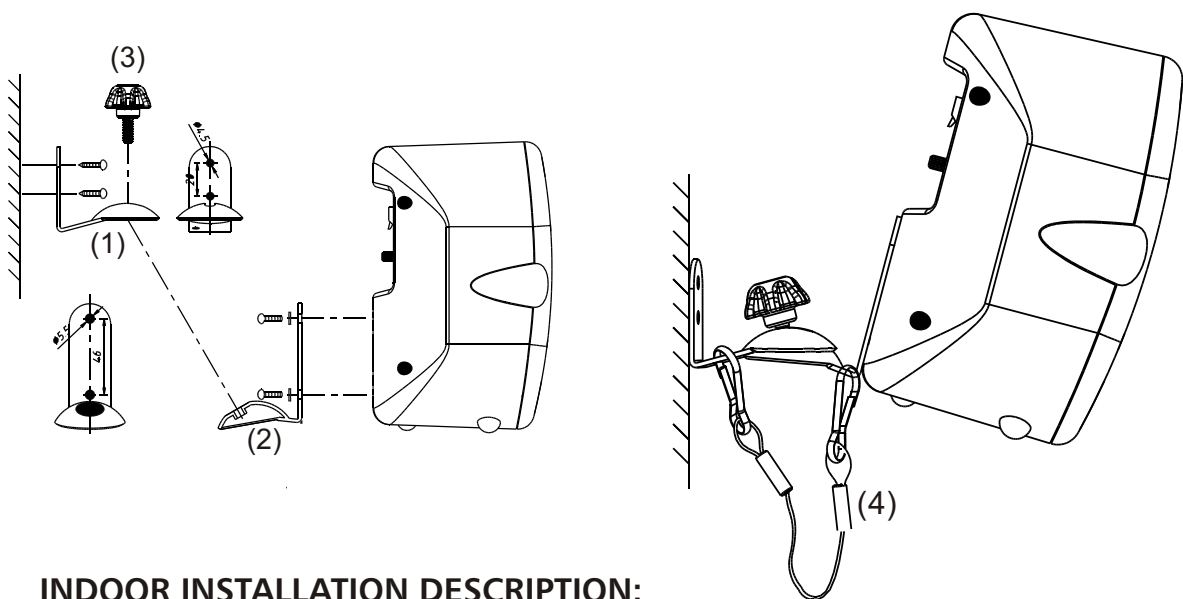

INDOOR INSTALLATION DESCRIPTION:

TAP series speakers are designed specially for fixing and using in different circumstances. The property of speakers may be different due to different circumstances. There is an acoustic surface (wall, floor and ceiling) in a closed room, so the acoustic indoor will turn complex. When acoustic wave hits the surface, a part of acoustic energy is reflected, others are absorbed.

Reflection and absorption are depending on the frequencies of acoustic wave and angle of hitting surface. When operate the cabinet, both man & furniture can absorb the acoustic energy. Please note the position of man and furniture when installing. Reverberation is the results of the reflected acoustic wave continue bouncing between the surfaces.

Installation Description

Every reflection will loss the energy. When the acoustic hit the reflection surface, the room will be filled with random reflected acoustic wave. The music and address will be complex. It is recommended that install more speakers and make the volume of speakers lower to reduce the reverberation in high reverberating room.

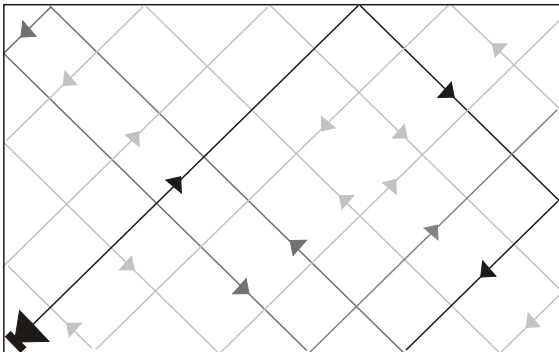

ONE LOUD SPEAKER
(Figure A)

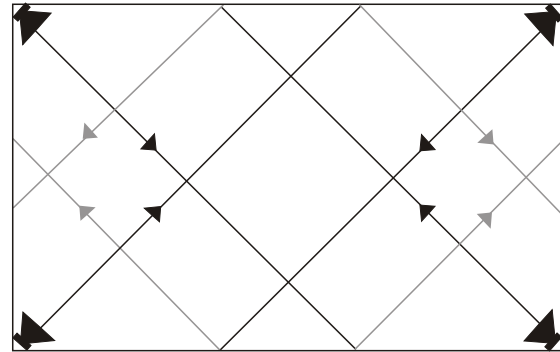

MULTIPLE QUIET SPEAKERS
(Figure B)

Speaker coverage range: Direct the center axile of the speaker to the flat surface of receiving area. The speakers of $90^{\circ} \times 90^{\circ}$ series can spread the speaker tone to all the directions at the axile of 45° . If you use the speakers in a large room, you can divide the room to some zones. Then decide the installing location of the speakers .

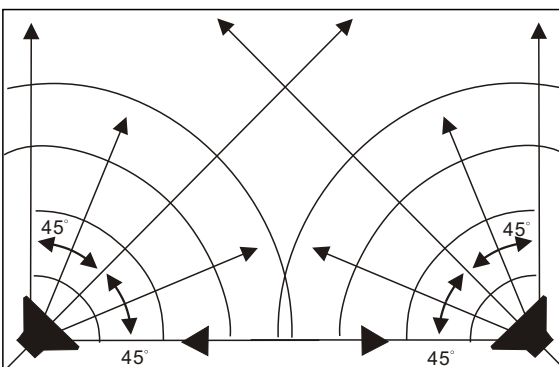

HORIZONTAL

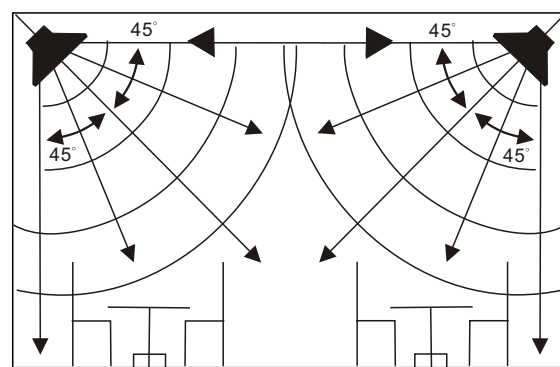

VERTICAL

7 Block Diagram

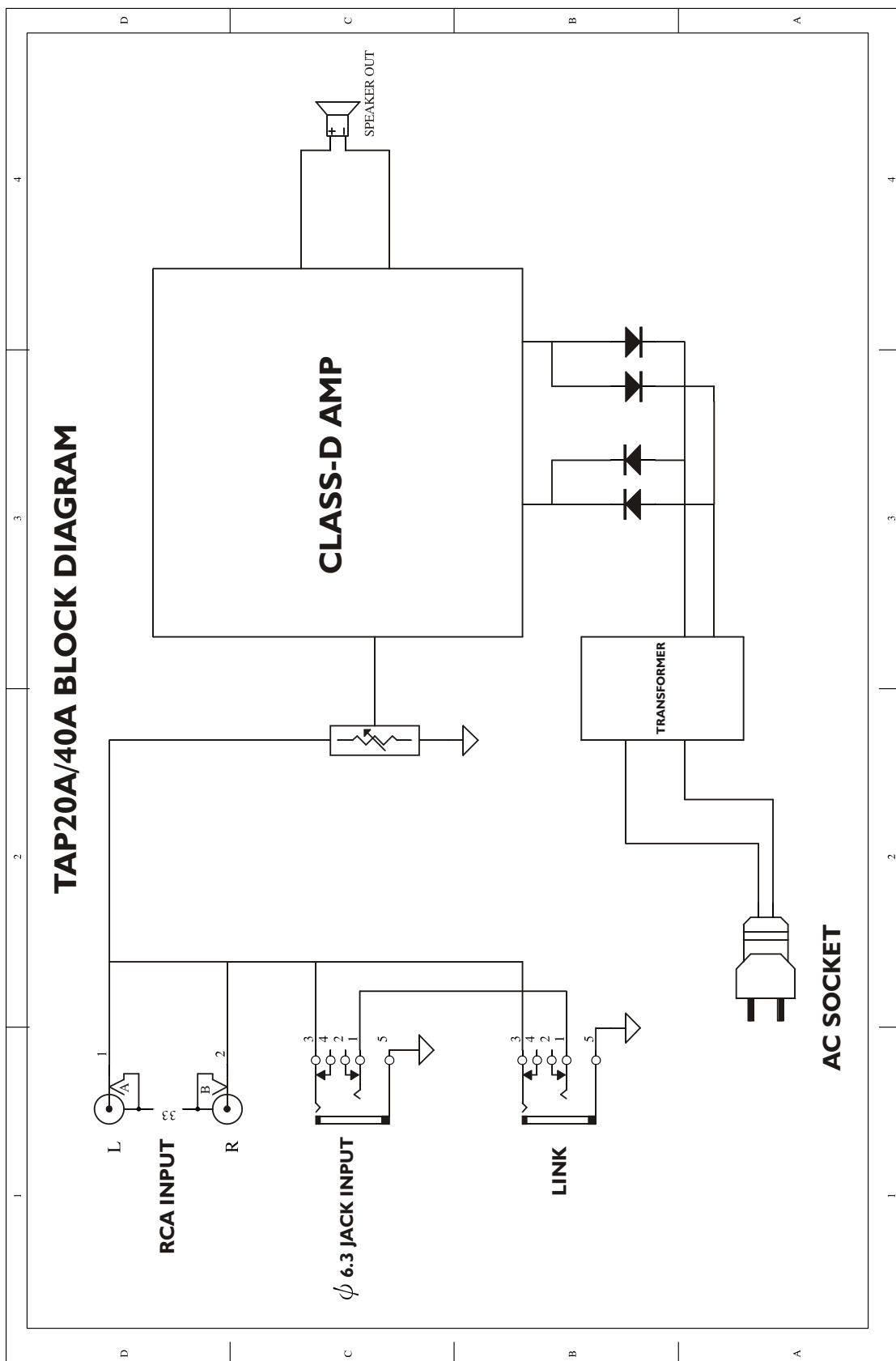

Frequency Response Diagram

TAP20A

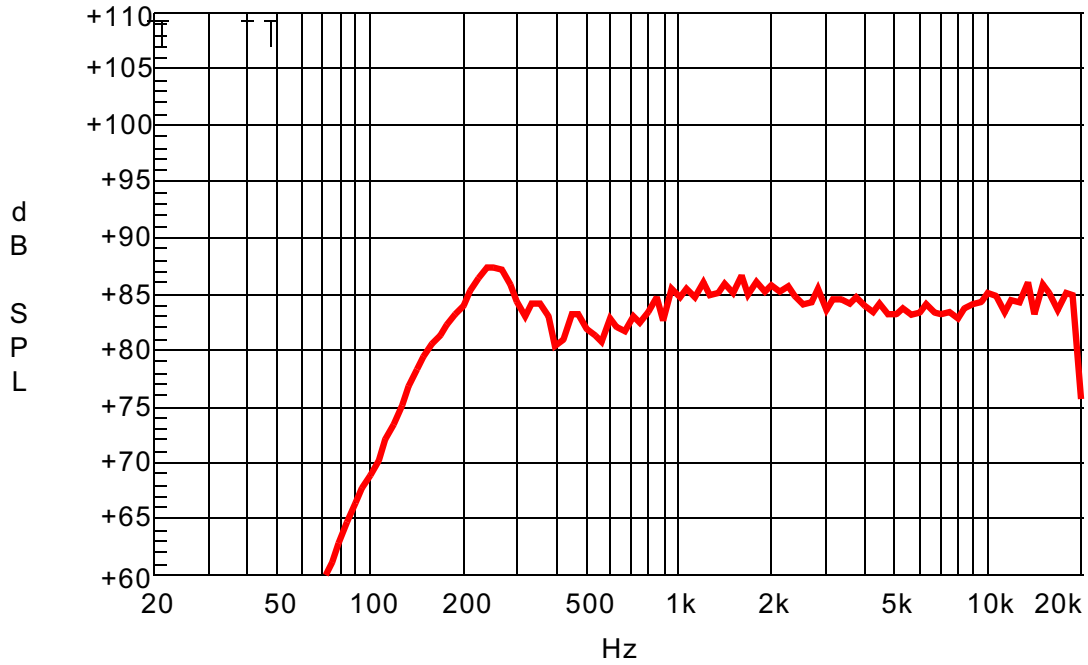

TAP20T

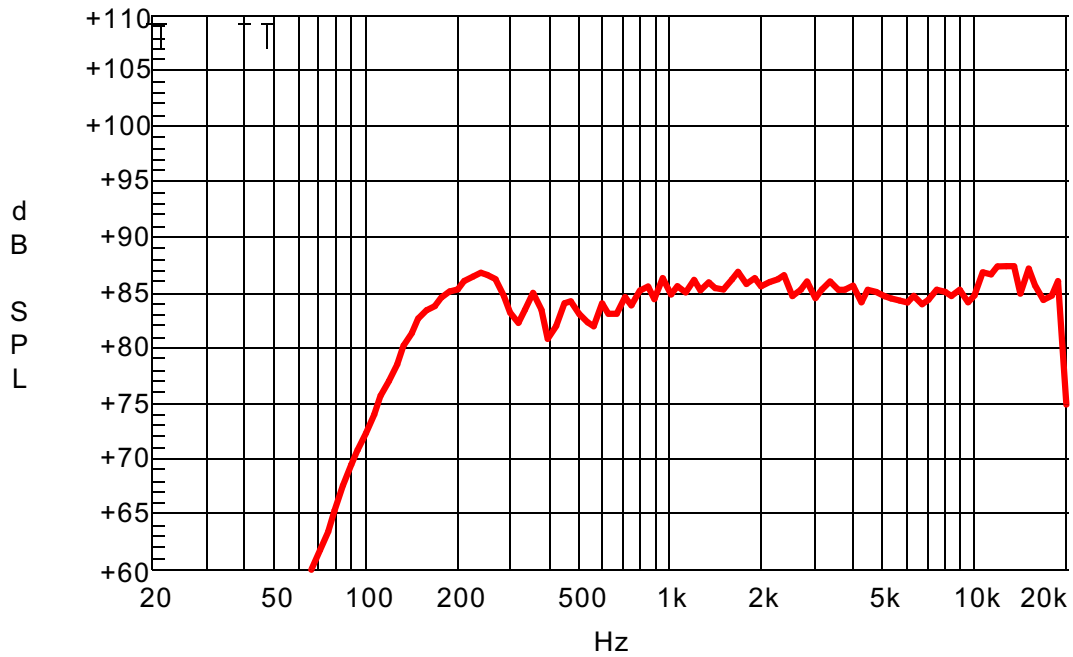

8

Frequency Response Diagram

TAP40A

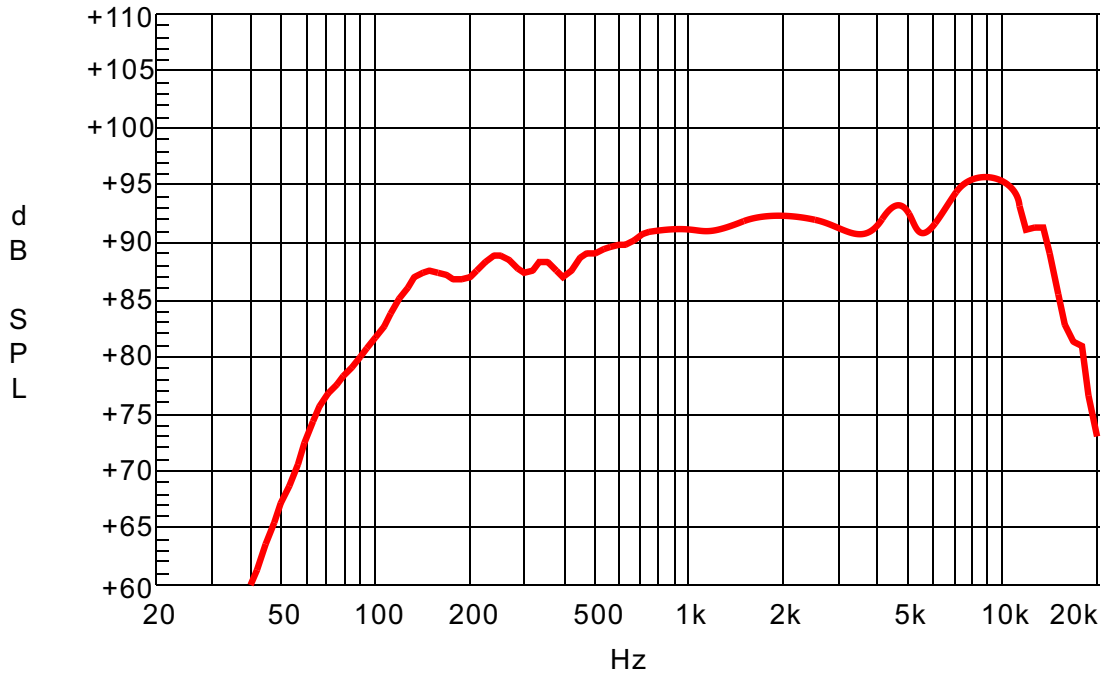

TAP40T

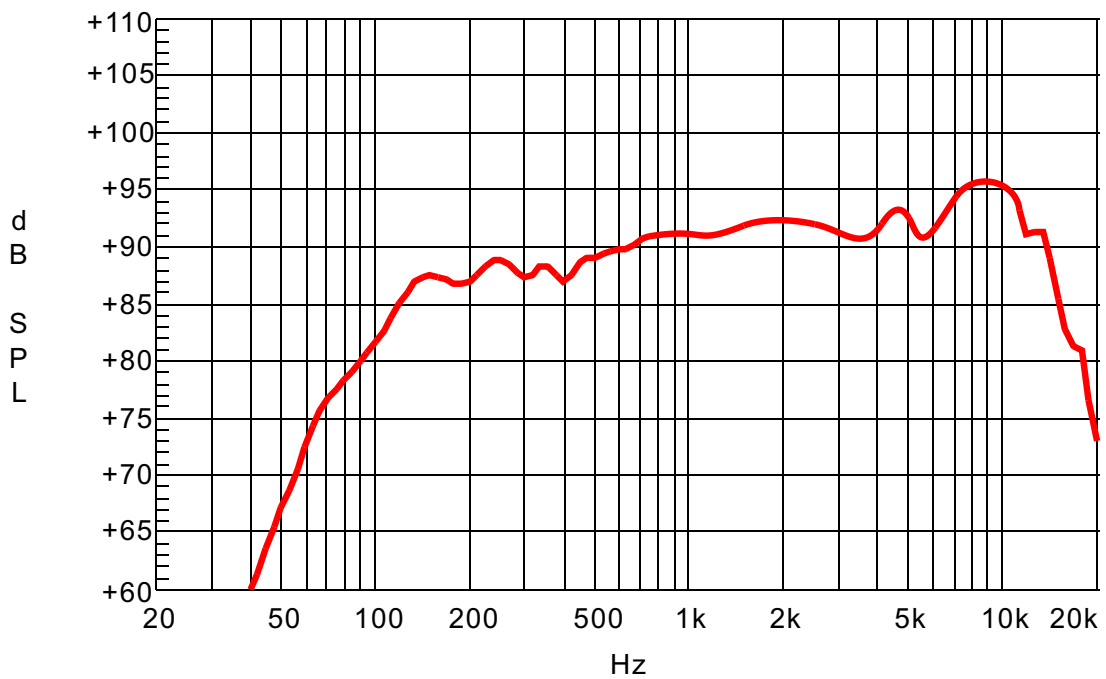

9

Technical Specification

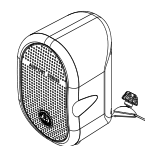

Model	TAP20T	TAP20A
System Type	Speaker cabinet with transformer	Active speaker cabinet
Speaker	3"(77*77mm)paper cone speaker 0.8"(20.4mm)voice coil diameter	3"(77*77mm)paper cone speaker 0.8"(20.4mm)voice coil diameter
SPL at 1m/1w	85 dB(±3dB)	85 dB(±3dB)
Frequency Response(-10dB)	132Hz-20KHz	132Hz-20KHz
Impedance	70V 245Ω/500Ω/1KΩ/2KΩ 100V 500Ω/1KΩ/2KΩ	4Ω
Power Rating	70V 20W/10W/5W/2.5W 100V 20W/10W/5W	20W (RMS)
Connector	Wiring Terminal	Input-RCA and φ 6.3 Balanced/ Output-link φ 6.3 Jack
External Controls	Power selective switch	Volume control/Power switch
Power Supply		220V-240V/50Hz 110V-120V/60Hz
Dimensions	115*107*175mm	115*107*175mm
Weight	1.12kg/2.47lbs	1.342kg/2.96lbs

Model	TAP40T	TAP40A
System Type	Speaker cabinet with transformer	Active speaker cabinet
Speaker	4"(106mm)paper cone speaker 1"(25.4mm)voice coil diameter	4"(106mm)paper cone speaker 1"(25.4mm)voice coil diameter
SPL at 1m/1w	90 dB(±3dB)	90 dB(±3dB)
Frequency Response(-10dB)	76Hz-18KHz	76Hz-18KHz
Impedance	70V 122Ω/250Ω/500Ω/1KΩ 100V 250Ω/500Ω/1KΩ	4Ω
Power Rating	70V 40W/20W/10W/5W 100V 40W/20W/10W	30W (RMS)
Connector	Wiring Terminal	Input-RCA and φ 6.3 Balanced/ Output-link φ 6.3 Jack
External Controls	Power selective switch	Volume control/Power switch
Power Supply		220V-240V/50Hz 110V-120V/60Hz
Dimensions	136*140*206mm	136*140*206mm
Weight	2.3kg/5.07lbs	2.40kg/5.29lbs
IP Grade	IP 44	

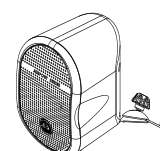

10 Guarantee

Topp Pro guarantees the normal operation of the product against any defect of manufacture and/or vice of material, by the term of (12) months, counted as of the date of purchase on the part of the user, committing itself to repair or to change, to its election, without position some, any piece or component that will fail in normal conditions of use within the mentioned period.

This guarantee is valid if the original buyer will have to present/display this certificate properly sealed and signed by the selling house, accompanied by the corresponding invoice of purchase where it consisted the model and serial number of the acquired equipment.

The guarantee does not cover:

- Damages caused by the illegal use of the product, repair and/or nonauthorized modification conducted by people by **Topp Pro**.
- Damages caused by the connection of the equipment to other equipment different from the specified ones in the manual of use, or by bad connection to these last ones.
- Damages caused by electrical storms, blows and/or incorrect transport.
- Damages caused by excesses or falls of tension in the network or by connection to networks with a tension different from the required one by the unit.
- Damages caused by the presence of sand, acid of batteries, water, or any strange element inside the equipment.
- Deteriorations produced by the course of the time, use and/or normal wear of the unit.
- Alteration or absence of the serial number of factory of the equipment.

The repairs could only be carried out the authorized technical service by **Topp Pro**, that will inform about the term and other details into the repairs to take place according to this guarantee.

Topp Pro, will repair this unit in counted a term nongreater to 30 days as of the date of entrance of the unit to the Technical Service. In those cases in that due to the particularity of the spare part, outside necessary their import, the repair time and the viability of the same one will be subject to the effective norms for the import of parts, in which case one will inquire to the user about the term and possibility into repair.

With the object of its correct operation, and of the validity of this one guarantee, this product will have to be installed and to be used according to the instructions that are detailed in the manual associate or the package of the product.

This unit will be able to appear for its repair, next to the invoice of purchase (or any other proof where the date of purchase consists), to its authorized distributor **Topp Pro** or an authorized technical center on watch by **Topp Pro**.

Exclusion of damages:

THE RESPONSABILITY OF TOPP PRO BY ANY DEFECTIVE PRODUCT IS LIMITED THE REPAIR OR THE REPLACEMENT OF HE HIMSELF, TO TOPP OPTION PRO. IF WE CHOSE TO REPLACE THE PRODUCT, THE REPLACEMENT CAN BE A RECONDITIONATED UNIT. TOPP PRO WILL NOT BE RESPONSIBLE BY THE DAMAGES BASED ON THE LOST, INCONVENIENCE, LOSS OF USE, BENEFITS, LOST SAVINGS, BY THE DAMAGE TO OTHER EQUIPMENT OR OTHER ARTICLES IN THE USE SITE, OR BY ANY OTHER DAMAGE IF HE IS FORTUITOUS, CONSEQUENT OR OF ANOTHER TYPE, ALTHOUGH TOPP PRO HAS BEEN NOTICED OF THE POSSIBILITY OF SUCH DAMAGES.

Some states do not allow to the exclusion or the limitation to the fortuitous or consequent damages, so the aforesaid limitation can not be applied to you.

This guarantee gives specific legal rights him, you can also have other right that varies of state to state.



TOPP PRO MUSIC GEAR

www.topppro.com

OUTDOORS
INDOORS
SPEAKER

NF03559-1.0