

Example Schematic
IP200UHD TX/RX
3 x 3 Matrix Configuration

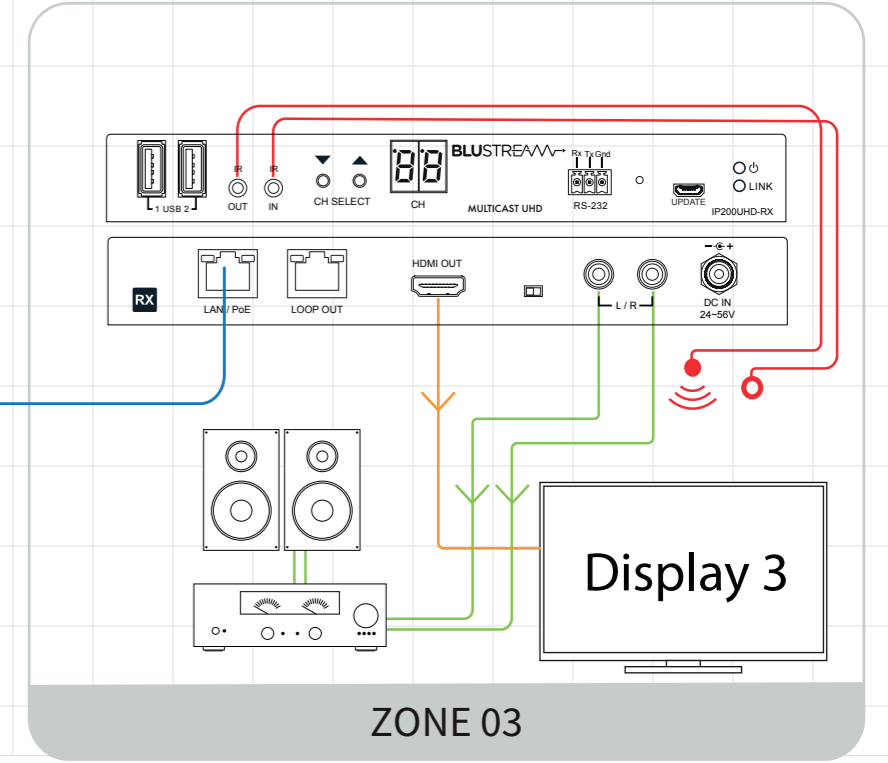

HDMI Over IP System Design – 3x3 Matrix configuration (Unlimited amount of configurations available)

Example Schematic
IP200UHD-RX/TX
One-To-Many

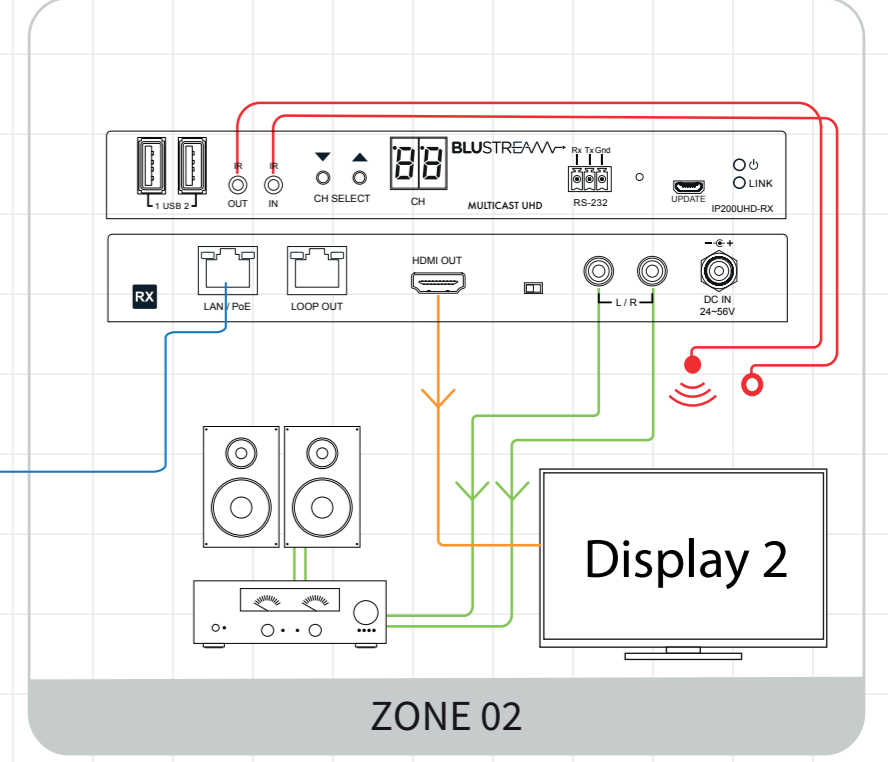
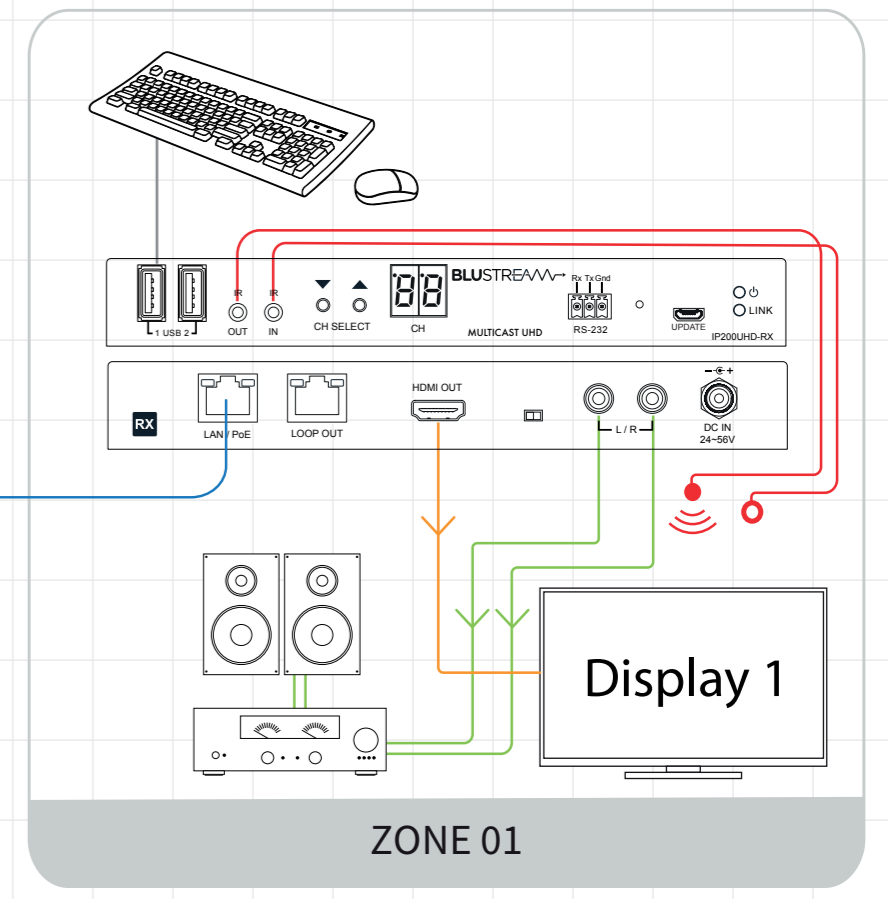
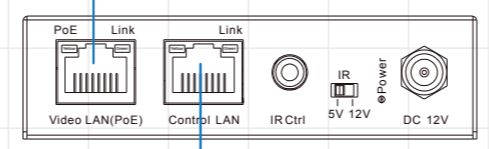
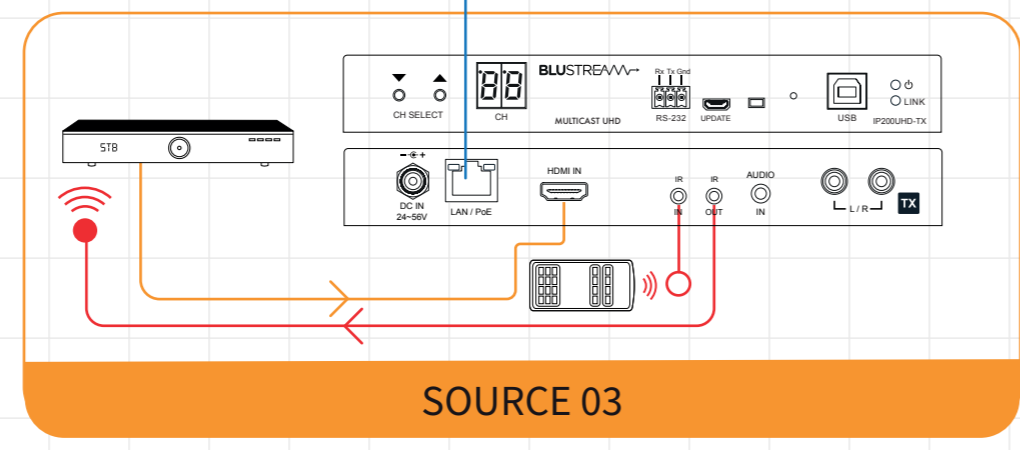
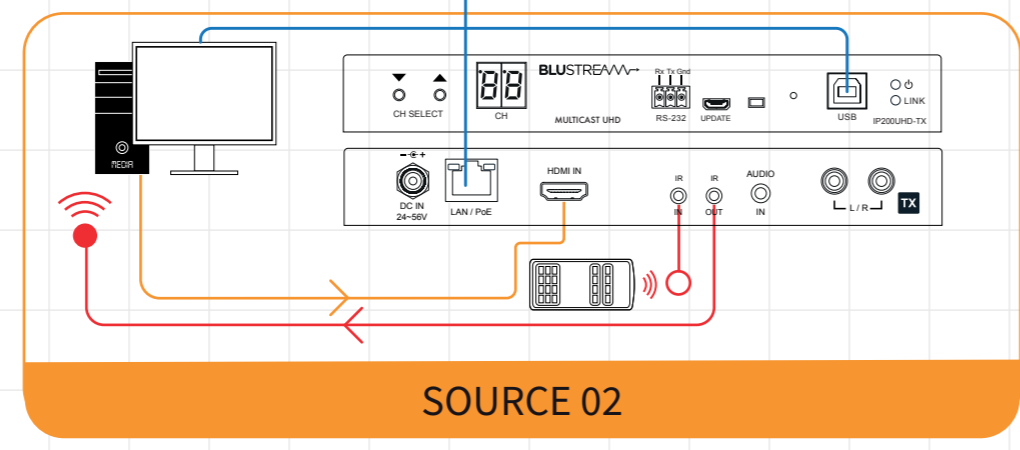
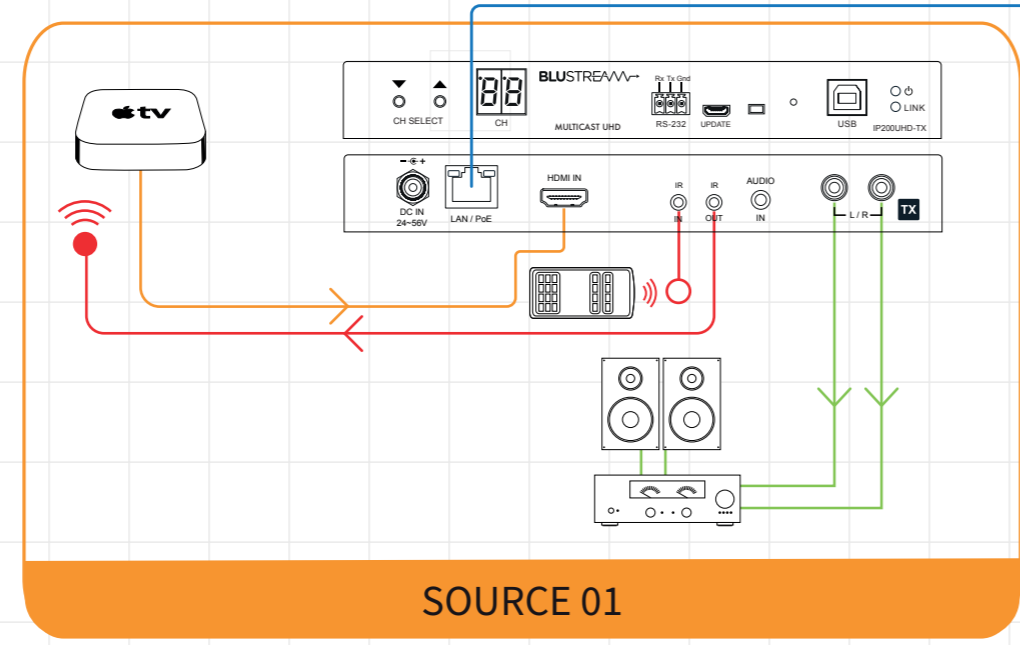
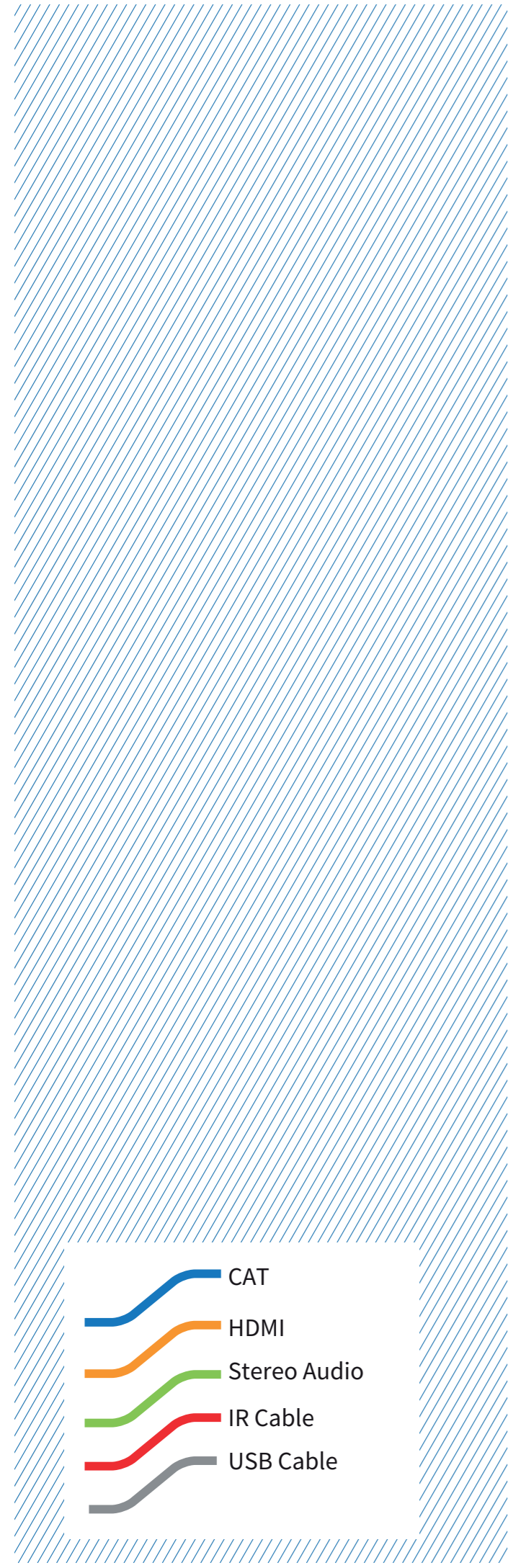
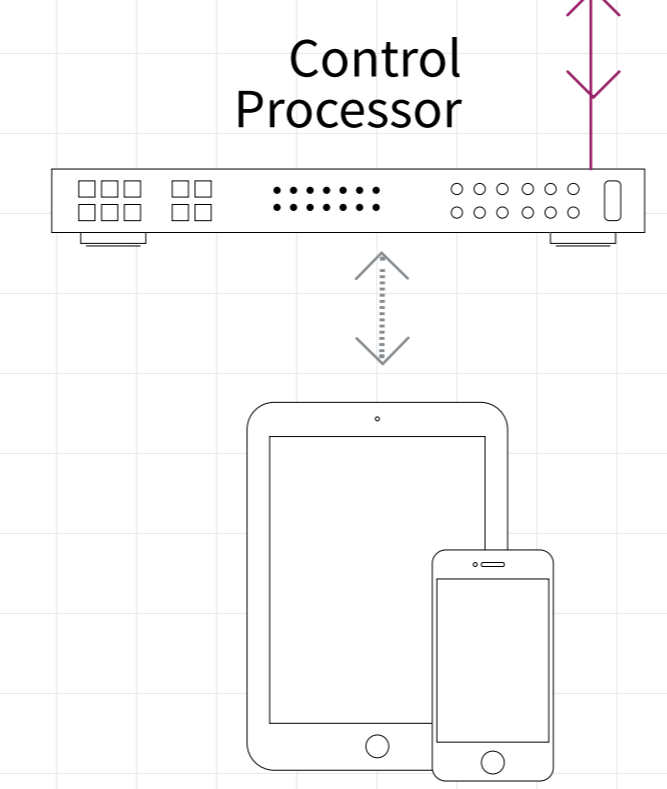
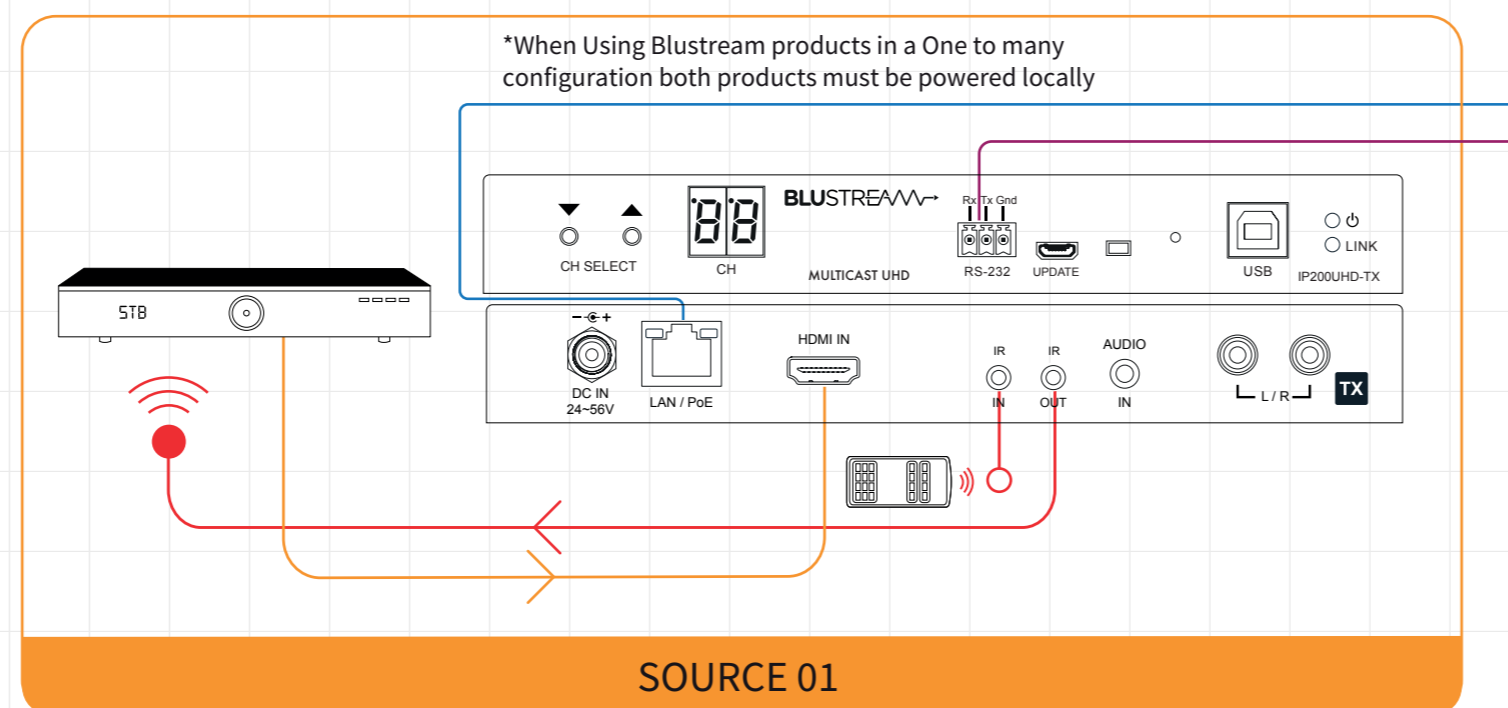
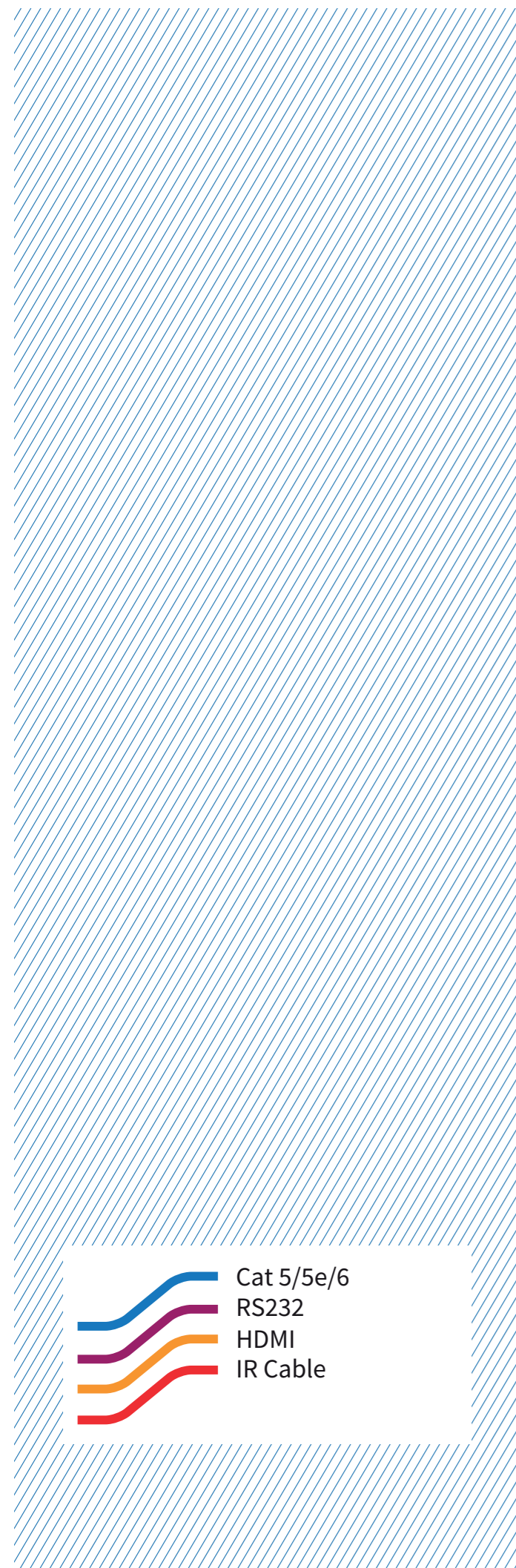



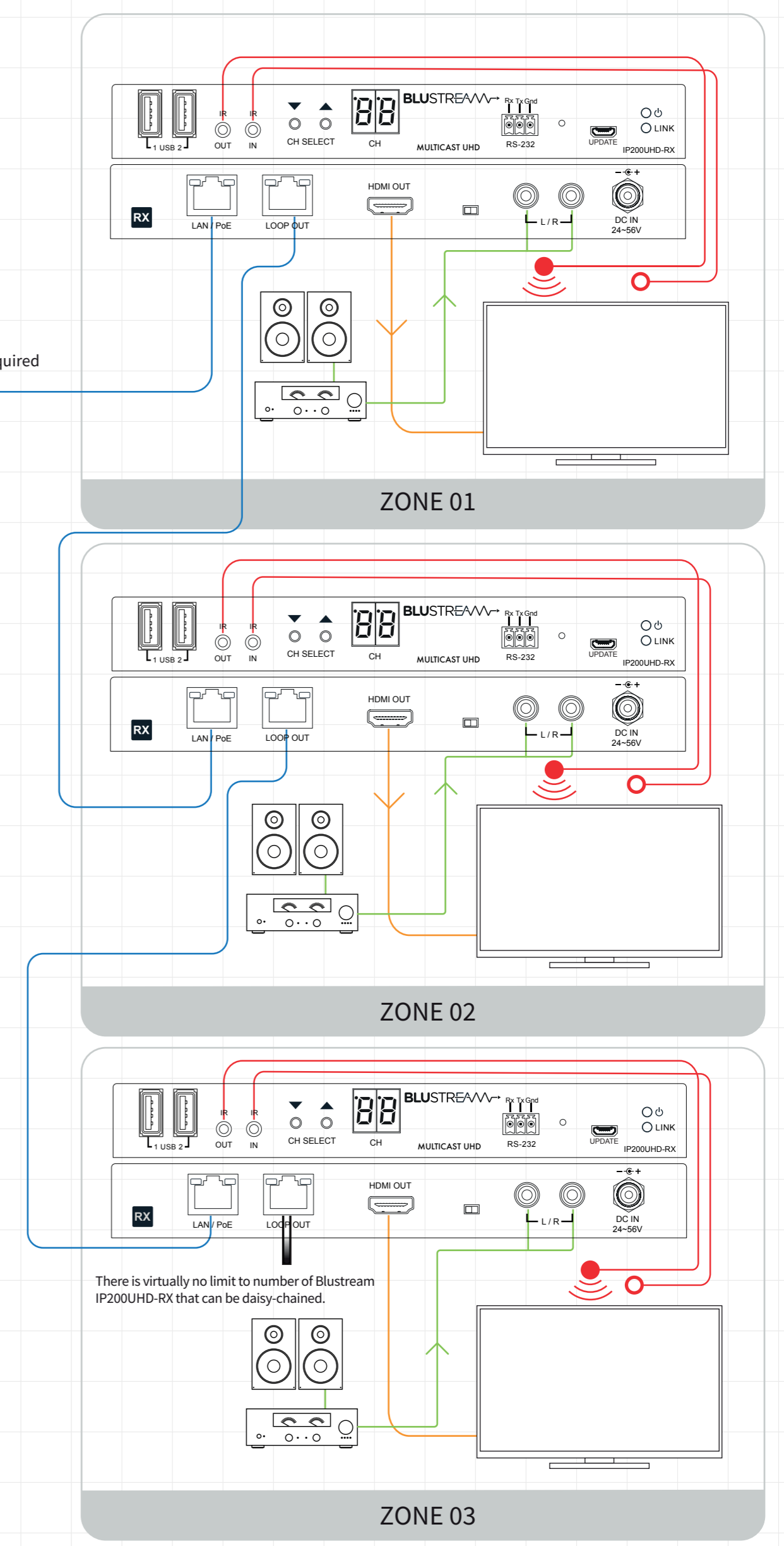



No network switch required

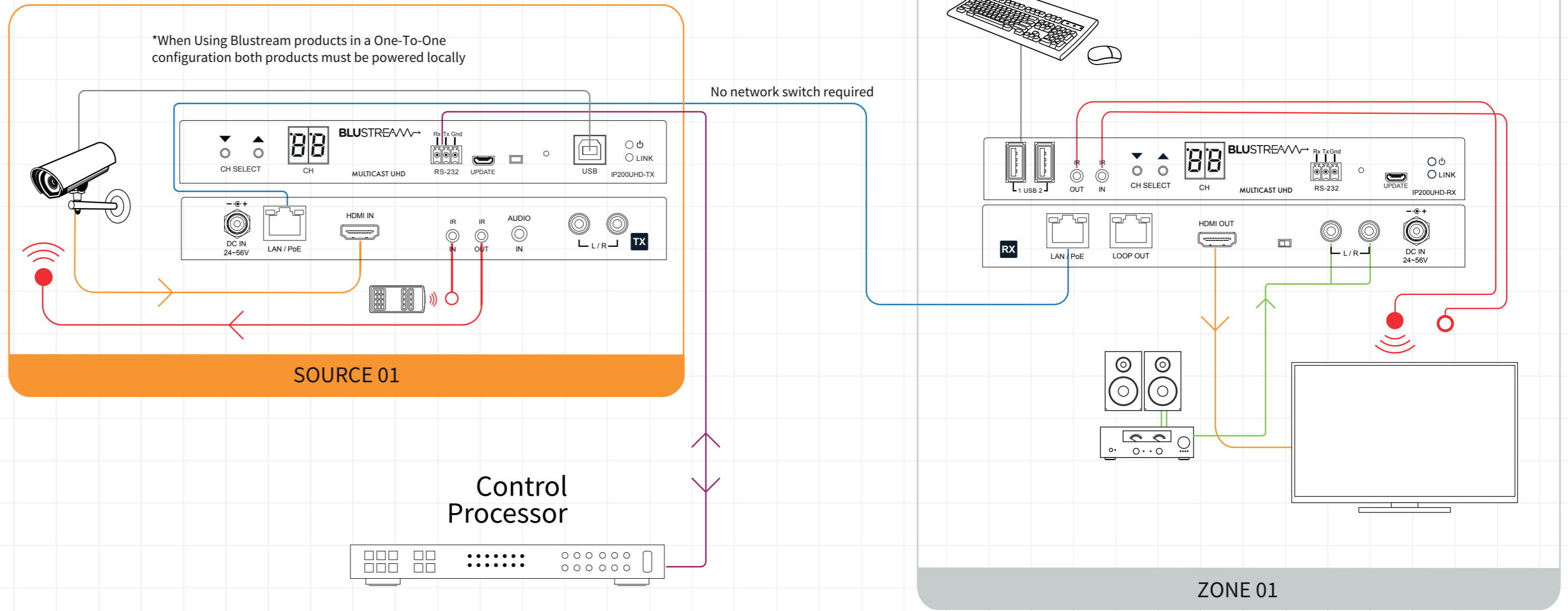

HDMI Over IP System Design – One-To-Many Distribution

Example Schematic
IP200UHD-RX/TX
One-To-One



-  Cat 5/5e/6
-  RS232
-  HDMI
-  IR Cable
-  USB Cable

HDMI Over IP System Design – One-To-One Distribution

Example Schematic
IP200UHD-RX/TX
Video Wall

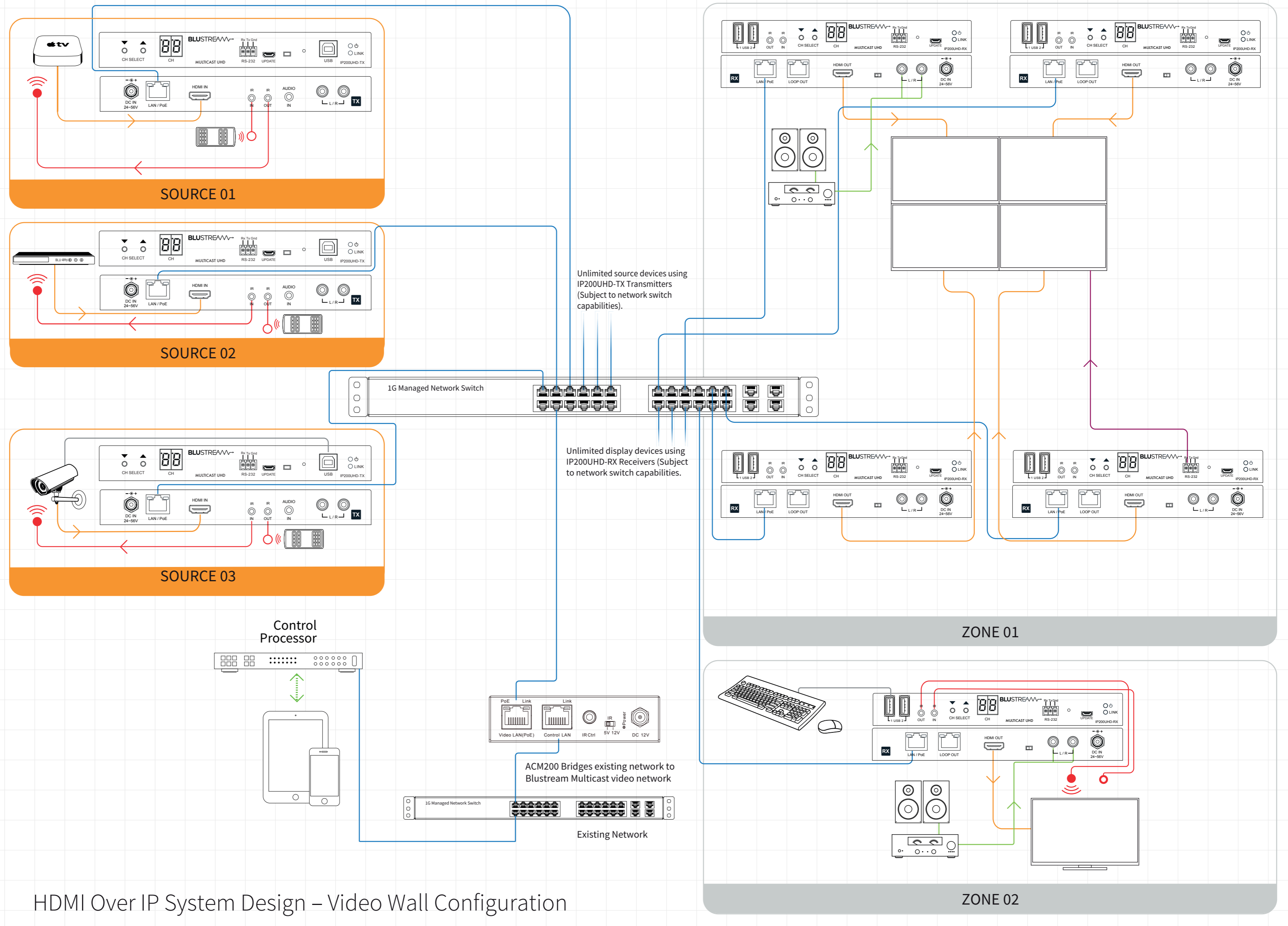
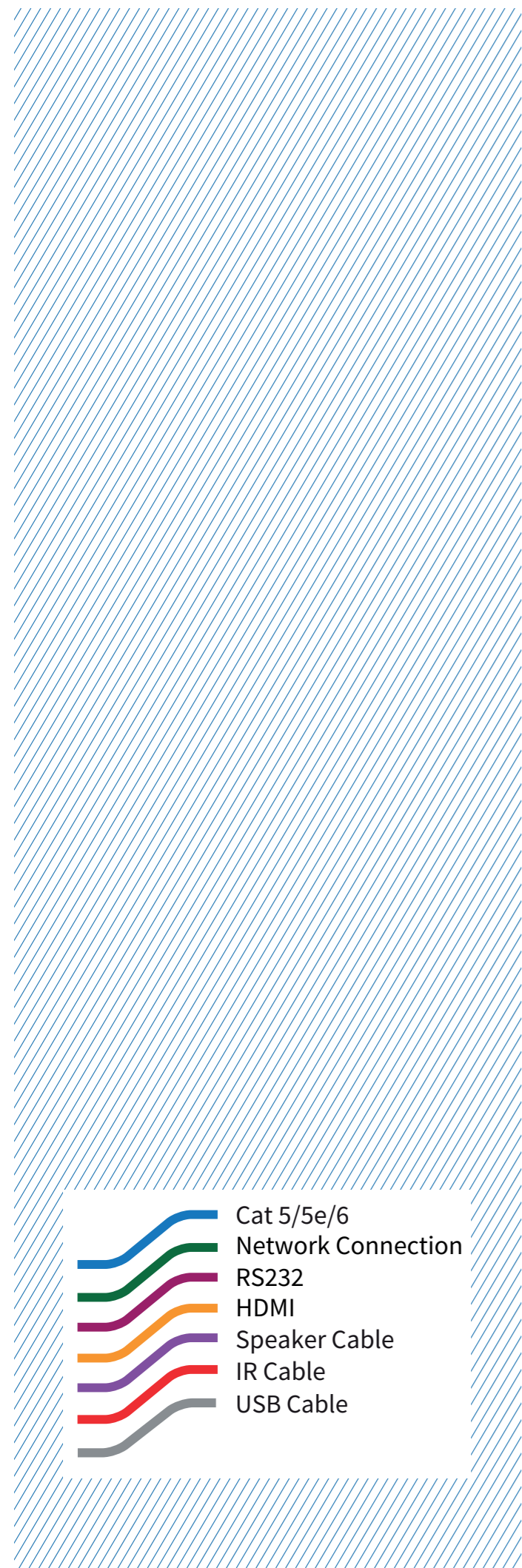

HDMI Over IP System Design – Video Wall Configuration